

ACCESS CODE

The access code (1 to 4 digits) is recommended to set sensors installed close to each other.

SAVING AN ACCESS CODE:



DELETING AN ACCESS CODE:



Once you have saved an access code, you always need to enter this code to unlock the sensor.

If you forget the access code, **cut and restore the power supply**. During 1 minute, you can access the sensor without introducing any access code.

TROUBLESHOOTING

	The door remains closed. The LED is OFF.	The sensor power is off.	1 Check the wiring and the power supply.
		The door control setting (F2) is set to value 3 (closed).	1 Change the door control setting (F2) to value 1 (automatic).
	The door does not react as expected.	Improper output configuration on the sensor.	1 Change the output configuration setting on each sensor connected to the door operator.
	The door opens and closes constantly.	The sensor is disturbed by the door motion or vibrations caused by the door motion.	1 Make sure the sensor is fixed properly. 2 Make sure the detection mode is unidirectional. 3 Increase the antenna angle. 4 Increase the immunity filter. 5 Reduce the field size.
	The door opens for no apparent reason.	It rains and the sensor detects the motion of the rain drops.	1 Make sure the detection mode is unidirectional. 2 Increase the immunity filter. 3 Install the ORA (rain accessory).
		In highly reflective environments, the sensor detects objects outside of its detection field.	1 Change the antenna angle. 2 Decrease the field size. 3 Increase the immunity filter.
		In airlock vestibules, the sensor detects the movement of the opposite door.	1 Change the antenna angle. 2 Change the antenna. 3 Increase the immunity filter.
	The LED flashes quickly after unlocking.	The sensor needs an access code to unlock.	1 Enter the right access code. 2 If you forgot the code, cut and restore the power supply to access the sensor without access code. Change or delete the access code.
	The sensor does not respond to the remote control.	Batteries in the remote control are weak or improperly installed.	1 Check and change the batteries if necessary.
		Remote control badly pointed.	1 Point the remote control towards the sensor.

EAGLE ONE & TWO

Opening sensor for automatic doors*

EAGLE ONE: energy-saving unidirectional sensor
EAGLE TWO: bidirectional sensor



DESCRIPTION

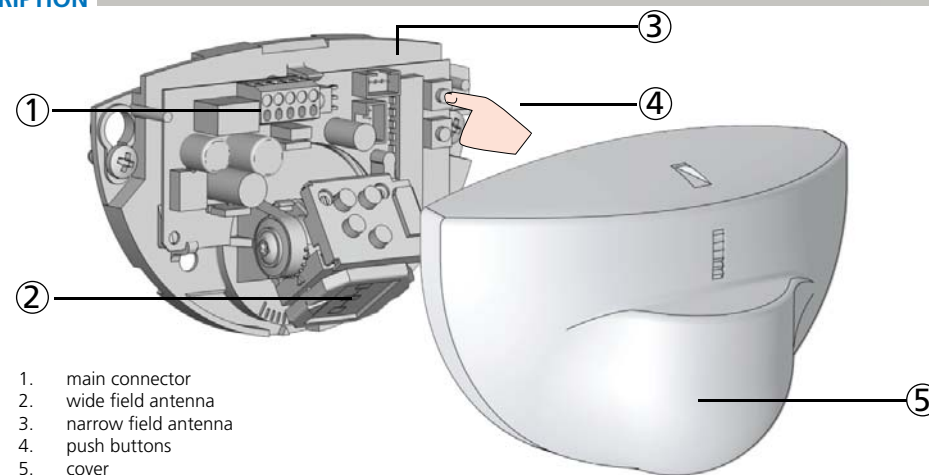

TECHNICAL SPECIFICATIONS

Technology:	microwave and microprocessor
Transmitter frequency:	24.150 GHz
Transmitter radiated power:	< 20 dBm EIRP
Transmitter power density:	< 5 mW/cm ²
Detection mode:	motion
Min. detection speed:	5 cm/s**
Supply voltage:	12V to 24V AC ±10%; 12V to 24V DC +30% / -10%
Mains frequency:	50 to 60 Hz
Max power consumption:	< 2 W
Output:	relay (free of potential change-over contact)
Max. contact voltage:	42V AC/DC
Max. contact current:	1A (resistive)
Max. switching power:	30W (DC) / 60VA (AC)
Mounting height:	from 1.8 m to 4 m
Degree of protection:	IP54**
Temperature range:	from -20 °C to + 55 °C
Dimensions:	120 mm (L) x 80 mm (H) x 50 mm (W)
Tilt angles:	0° to 90° vertical; -30° to +30° lateral
Material:	ABS
Weight:	215 g
Cable length:	2.5 m
Norm conformity:	R&TTE 1999/5/EC; EMC 2004/108/EC

Specifications are subject to changes without prior notice.

* Other use of the device is outside the permitted purpose and can not be guaranteed by the manufacturer.

** Measured in optimal conditions

BEA SA | LIEGE Science Park | ALLÉE DES NOISÉTIERS 5 - 4031 ANGLEUR (BELGIUM) | T +32 4 361 65 65 | F +32 4 361 28 58 | INFO@BEA.BE | WWW.BEA.BE



BEA hereby declares that the EAGLE is in conformity with the basic requirements and the other relevant provisions of the directives 1999/5/EC and 2004/108/EC.

Angleur, July 2010

Jean-Pierre Valkenberg, R&D Manager (Authorized representative)

The complete declaration of conformity is available on our website: www.bea.be



1 OPENING THE SENSOR

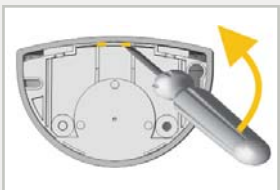

Before fixing



After fixing

2 MOUNTING & WIRING

TIPS

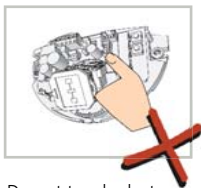

Do not touch electrical parts.



Avoid vibrations.



Do not cover the sensor.



Avoid proximity to neon lamps or moving objects.

APPLICATIONS

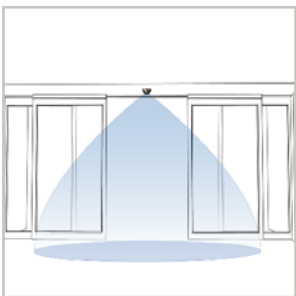

Wall mounting above sliding or revolving door

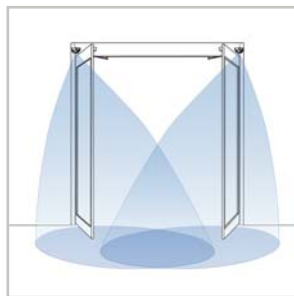

Mounting on door axis (swing doors)

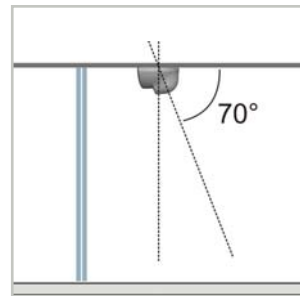

Ceiling mounting in front of door (sliding, revolving or swing doors)

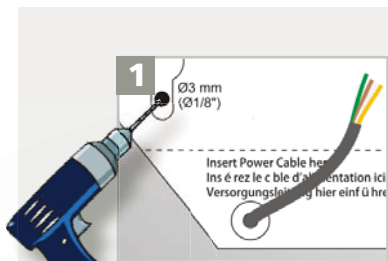

Apply the mounting template. Drill 1 hole for the cable and pull it through. Drill 2 holes for the screws.

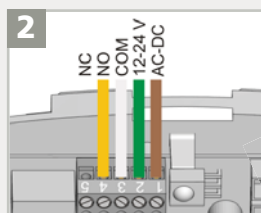

Connect the wires accordingly:
 1 - BROWN - POWER SUPPLY
 2 - GREEN - POWER SUPPLY
 3 - WHITE - COM
 4 - YELLOW - NO
 5 - YELLOW - NC

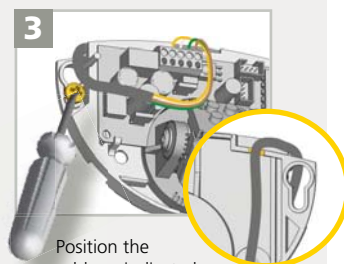

Position the cable as indicated. Fix the sensor firmly.

3 MECHANICAL ADJUSTMENTS

WIDTH

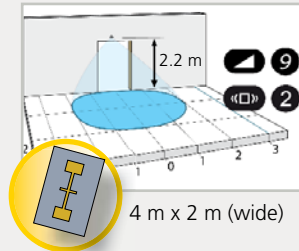

4 m x 2 m (wide)

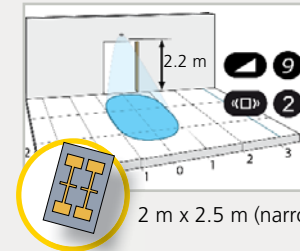

2 m x 2.5 m (narrow)

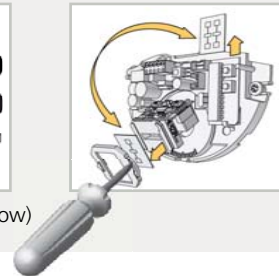

ANGLE

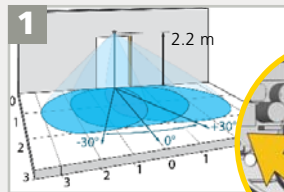

Adjust the lateral antenna angle.

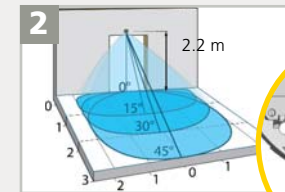

Adjust the vertical antenna angle.

4 SETTINGS (by remote control or push buttons)



FIELD SIZE (SENSITIVITY)	XXS	XS	S	>	>	>	>	L	XL	XXL
IMMUNITY FILTER		low	normal	high	>	>	>	>	>	highest
DETECTION MODE		bi	uni	uni PRM	uni AWAY	PRM & AWAY	bi = two-way detection; uni = one-way detection towards sensor uni PRM = one-way detection also of people with reduced mobility uni AWAY = one-way detection away from sensor			
OUTPUT CONFIGURATION		A	P	A = active output (NO-contact) P = passive output (NC-contact)						
HOLD-OPEN TIME	0.5 s	1 s	2 s	3 s	4 s	5 s	6 s	7 s	8 s	9 s
MOUNTING HEIGHT		< 3 m	> 3 m							
DOOR CONTROL		auto	open	closed	open = the sensor detects constantly. The LED is ON. closed = the sensor is in standby and does not detect. The LED is OFF.					

FACTORY VALUES
 EAGLE TWO DETECTION MODE FACTORY VALUE
 EAGLE ONE DETECTION MODE FACTORY VALUE
 ONLY AVAILABLE ON EAGLE ONE

RESETTING TO FACTORY VALUES: [Lock] [0] [9] OR [Lock] [9] > 2 seconds

FIELD SIZE

... S, XS, XXS
 ... L, XL, XXL